

LAMPIRAN A

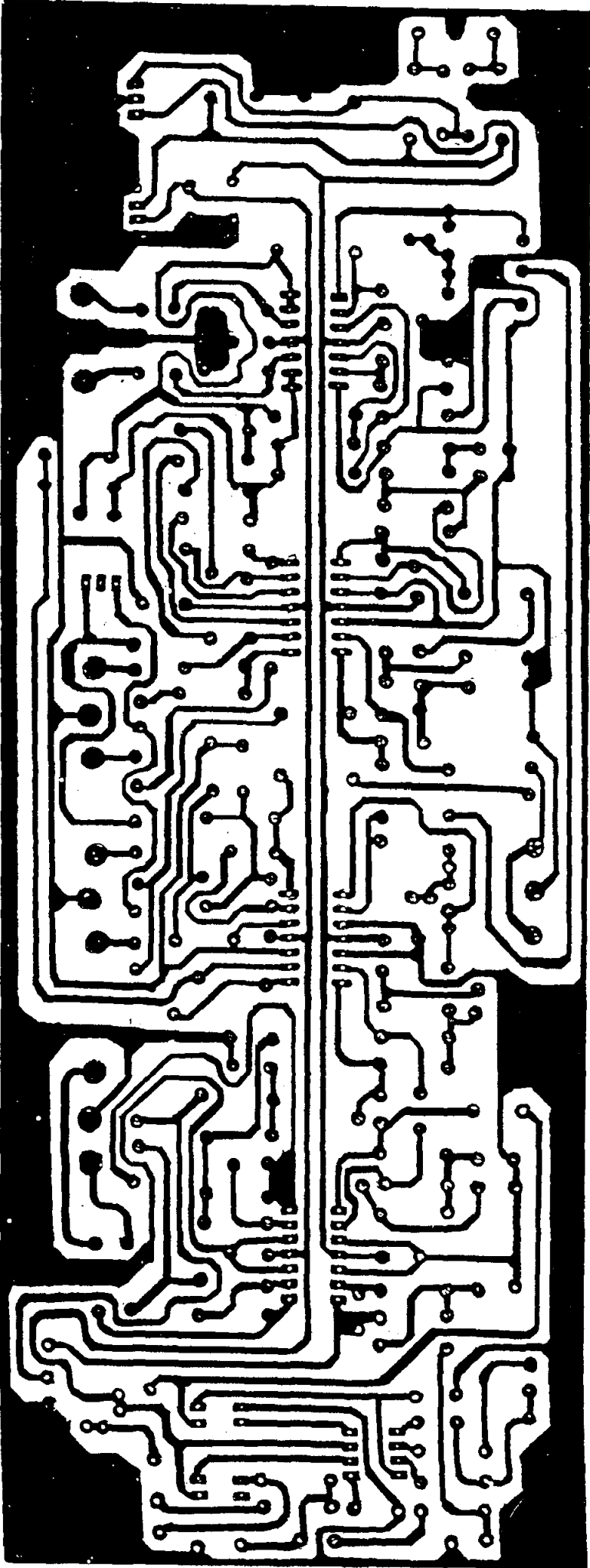

LAMPIRAN B

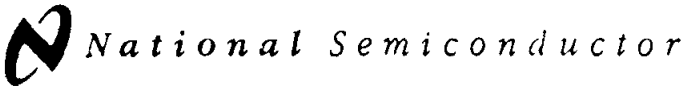

LF147/LF347 Wide Bandwidth Quad JFET Input Operational Amplifiers

General Description

The LF147 is a low cost, high speed quad JFET input operational amplifier with an internally trimmed input offset voltage (BI-FET II™ technology). The device requires a low supply current and yet maintains a large gain bandwidth product and a fast slew rate. In addition, well matched high voltage JFET input devices provide very low input bias and offset currents. The LF147 is pin compatible with the standard LM148. This feature allows designers to immediately upgrade the overall performance of existing LF148 and LM124 designs.

The LF147 may be used in applications such as high speed integrators, fast D/A converters, sample-and-hold circuits and many other circuits requiring low input offset voltage, low input bias current, high input impedance, high slew rate and wide bandwidth. The device has low noise and offset voltage drift.

Features

- Internally trimmed offset voltage 5 mV max
- Low input bias current 50 pA
- Low input noise current 0.01 pA/√Hz
- Wide gain bandwidth 4 MHz
- High slew rate 13 V/μs
- Low supply current 7.2 mA
- High input impedance 10¹²Ω
- Low total harmonic distortion $A_V = 10$, $R_L = 10k$, $V_O = 20$ Vp-p, BW = 20 Hz - 20 kHz <0.02%
- Low 1/f noise corner 50 Hz
- Fast settling time to 0.01% 2 μs

Simplified Schematic

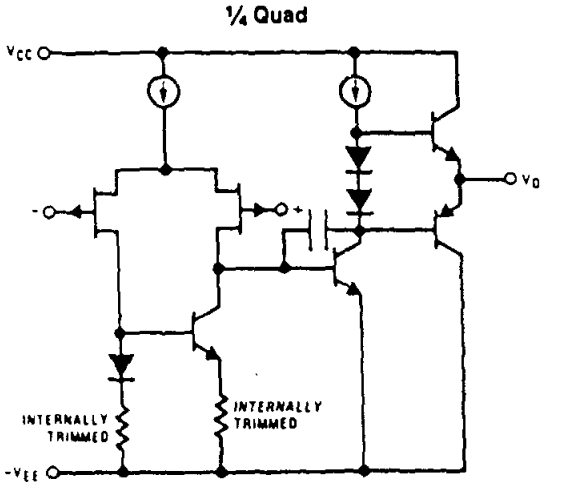

TL/H/5647-13

Connection Diagram

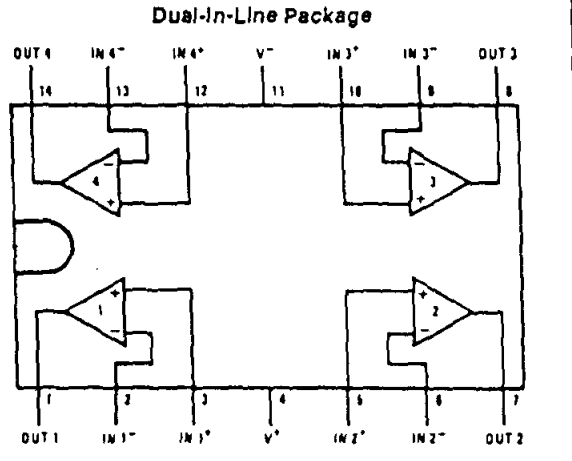

TL/H/5647-1

Top View

Order Number LF147J, LF347M, LF347BN,
 LF347N, LF147D/883 or LF147J/883*
 See NS Package Number D14E, J14A, M14A or N14A

*Available per SMD #8102306, JM38510/11906.

Absolute Maximum Ratings

If Military/Aerospace specified devices are required, please contact the National Semiconductor Sales Office/Distributors for availability and specifications.

	LF147	LF347B/LF347
Supply Voltage	±22V	±18V
Differential Input Voltage	±38V	±30V
Input Voltage Range (Note 1)	±19V	±15V
Output Short Circuit Duration (Note 2)	Continuous	Continuous
Power Dissipation (Notes 3 and 9)	900 mW	1000 mW
T_J max	150°C	150°C
θ_{JA}		
Cavity DIP (D) Package		80°C/W
Ceramic DIP (J) Package		70°C/W
Plastic DIP (N) Package		75°C/W
Surface Mount Narrow (M)		100°C/W
Surface Mount Wide (WM)		85°C/W

	LF147 (Note 4)	LF347B/LF347 (Note 4)
Operating Temperature Range		
Storage Temperature Range		-65°C ≤ T _A ≤ 150°C
Lead Temperature (Soldering, 10 sec.)	260°C	260°C
Soldering Information		
Dual-In-Line Package		
Soldering (10 seconds)		260°C
Small Outline Package		
Vapor Phase (60 seconds)		215°C
Infrared (15 seconds)		220°C
See AN-450 "Surface Mounting Methods and Their Effect on Product Reliability" for other methods of soldering surface mount devices.		
ESD Tolerance (Note 10)		900V

DC Electrical Characteristics (Note 5)

Symbol	Parameter	Conditions	LF147			LF347B			LF347			Units
			Min	Typ	Max	Min	Typ	Max	Min	Typ	Max	
V _{OS}	Input Offset Voltage	R _S = 10 kΩ, T _A = 25°C Over Temperature		1	5 8		3	5 7		5	10 13	mV mV
ΔV _{OS} /ΔT	Average TC of Input Offset Voltage	R _S = 10 kΩ		10			10			10		μV/°C
I _{OS}	Input Offset Current	T _J = 25°C, (Notes 5, 6) Over Temperature		25	100 25		25	100 4		25	100 4	pA nA
I _B	Input Bias Current	T _J = 25°C, (Notes 5, 6) Over Temperature		50	200 50		50	200 8		50	200 8	pA nA
R _{IN}	Input Resistance	T _J = 25°C		10 ¹²			10 ¹²			10 ¹²		Ω
A _{VOL}	Large Signal Voltage Gain	V _S = ±15V, T _A = 25°C V _O = ±10V, R _L = 2 kΩ Over Temperature	50	100		50	100		25	100		V/mV
			25		25		15		V/mV			
V _o	Output Voltage Swing	V _S = ±15V, R _L = 10 kΩ	±12	±13.5		±12	±13.5		±12	±13.5		V
V _{CM}	Input Common-Mode Voltage Range	V _S = ±15V	±11	+15 -12		±11	+15 -12		±11	+15 -12		V V
CMRR	Common-Mode Rejection Ratio	R _S ≤ 10 kΩ	80	100		80	100		70	100		dB
PSRR	Supply Voltage Rejection Ratio	(Note 7)	80	100		80	100		70	100		dB
I _S	Supply Current			7.2	11		7.2	11		7.2	11	mA

AC Electrical Characteristics (Note 5)

Symbol	Parameter	Conditions	LF147			LF347B			LF347			Units
			Min	Typ	Max	Min	Typ	Max	Min	Typ	Max	
	Amplifier to Amplifier Coupling	$T_A = 25^\circ\text{C}$, $f = 1\text{ Hz} - 20\text{ kHz}$ (Input Referred)		-120			-120			-120		dB
SR	Slew Rate	$V_S = \pm 15\text{V}$, $T_A = 25^\circ\text{C}$	8	13		8	13		8	13		$\text{V}/\mu\text{s}$
GBW	Gain-Bandwidth Product	$V_S = \pm 15\text{V}$, $T_A = 25^\circ\text{C}$	2.2	4		2.2	4		2.2	4		MHz
e_n	Equivalent Input Noise Voltage	$T_A = 25^\circ\text{C}$, $R_S = 100\Omega$, $f = 1000\text{ Hz}$		20			20			20		$\text{nV}/\sqrt{\text{Hz}}$
i_n	Equivalent Input Noise Current	$T_J = 25^\circ\text{C}$, $f = 1000\text{ Hz}$		0.01			0.01			0.01		$\text{pA}/\sqrt{\text{Hz}}$

Note 1: Unless otherwise specified the absolute maximum negative input voltage is equal to the negative power supply voltage.

Note 2: Any of the amplifier outputs can be shorted to ground indefinitely, however, more than one should not be simultaneously shorted as the maximum junction temperature will be exceeded.

Note 3: For operating at elevated temperature, these devices must be derated based on a thermal resistance of θ_{JA} .

Note 4: The LF147 is available in the military temperature range $-55^\circ\text{C} \leq T_A \leq 125^\circ\text{C}$, while the LF347B and the LF347 are available in the commercial temperature range $0^\circ\text{C} \leq T_A \leq 70^\circ\text{C}$. Junction temperature can rise to $T_J \text{ max} = 150^\circ\text{C}$.

Note 5: Unless otherwise specified the specifications apply over the full temperature range and for $V_S = \pm 20\text{V}$ for the LF147 and for $V_S = \pm 15\text{V}$ for the LF347B/LF347. V_{OS} , I_B , and I_{OS} are measured at $V_{CM} = 0$.

Note 6: The input bias currents are junction leakage currents which approximately double for every 10°C increase in the junction temperature, T_J . Due to limited production test time, the input bias currents measured are correlated to junction temperature. In normal operation the junction temperature rises above the ambient temperature as a result of internal power dissipation, P_D . $T_J = T_A + \theta_{JA} P_D$ where θ_{JA} is the thermal resistance from junction to ambient. Use of a heat sink is recommended if input bias current is to be kept to a minimum.

Note 7: Supply voltage rejection ratio is measured for both supply magnitudes increasing or decreasing simultaneously in accordance with common practice from $V_S = \pm 5\text{V}$ to $\pm 15\text{V}$ for the LF347 and LF347B and from $V_S = \pm 20\text{V}$ to $\pm 5\text{V}$ for the LF147.

Note 8: Refer to RETS147X for LF147D and LF147J military specifications.

Note 9: Max. Power Dissipation is defined by the package characteristics. Operating the part near the Max. Power Dissipation may cause the part to operate outside guaranteed limits.

Note 10: Human body model, $1.5\text{ k}\Omega$ in series with 100 pF .

Typical Performance Characteristics

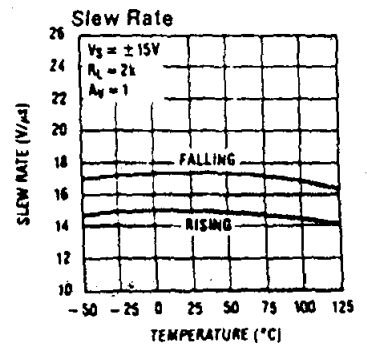
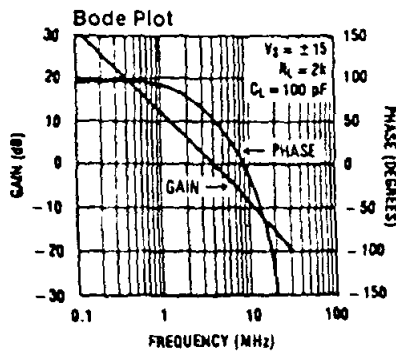
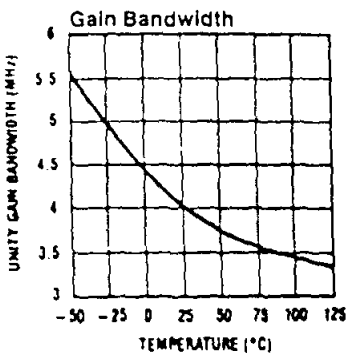
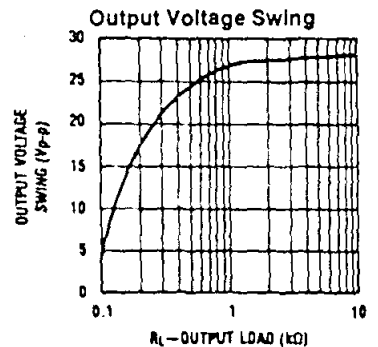
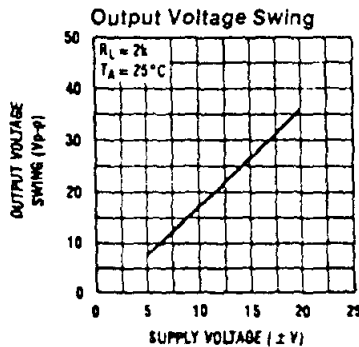
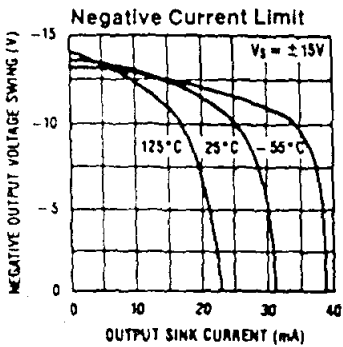
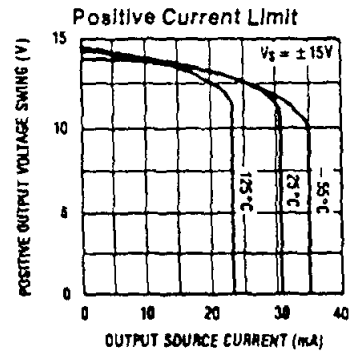
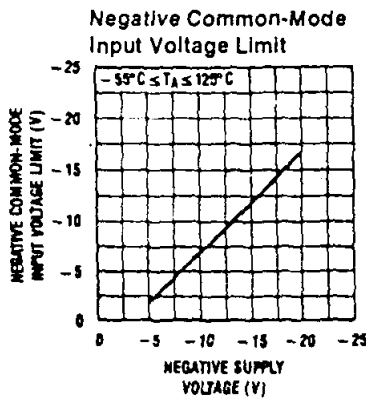
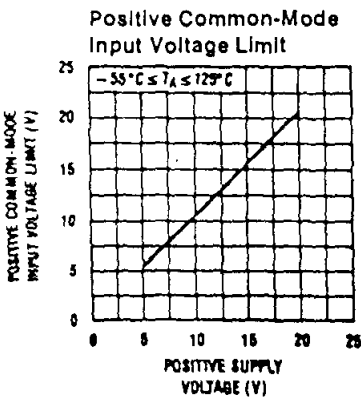
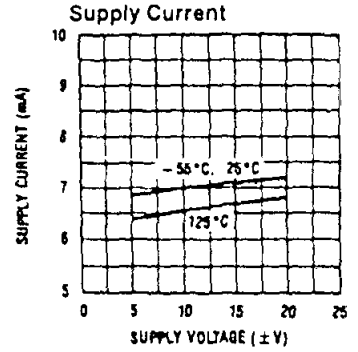
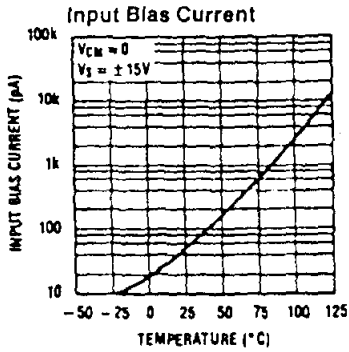
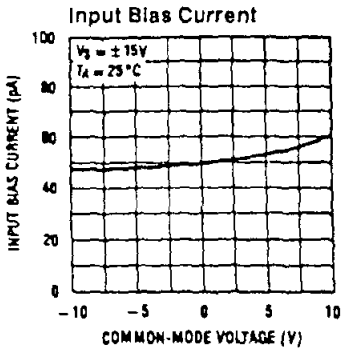

TL/H/5647-2

LF147/LF347

Typical Performance Characteristics (Continued)

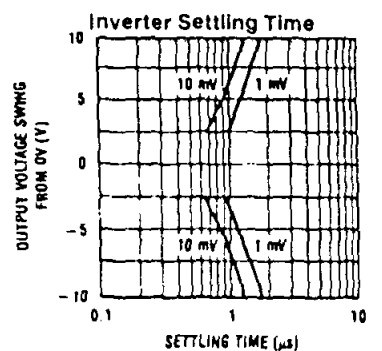
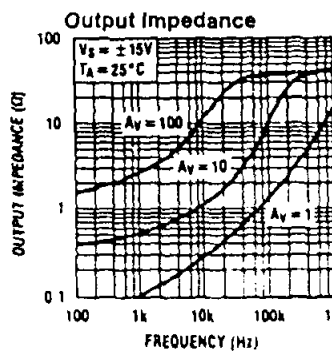
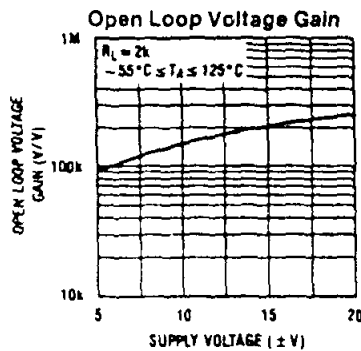
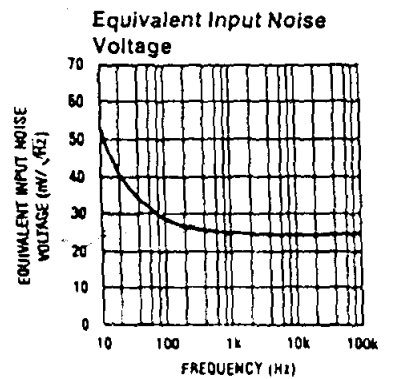
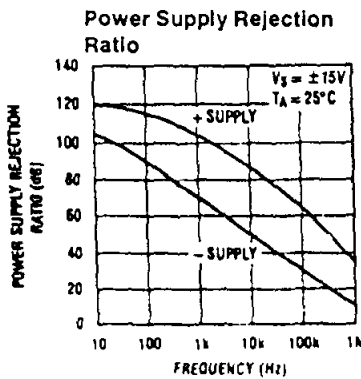
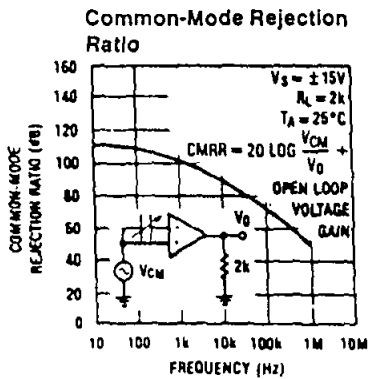
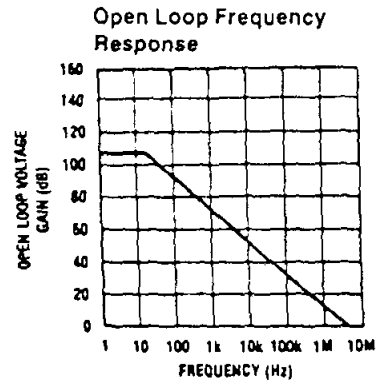
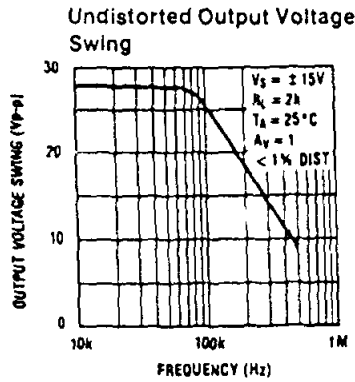
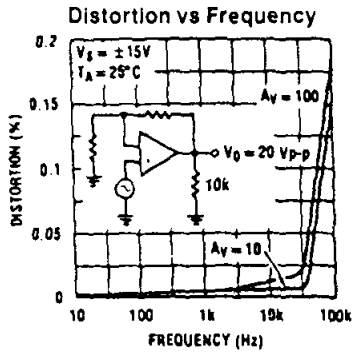

TL1115647-3

Pulse Response $R_L = 2\text{ k}\Omega, C_L = 10\text{ pF}$

Small Signal Inverting

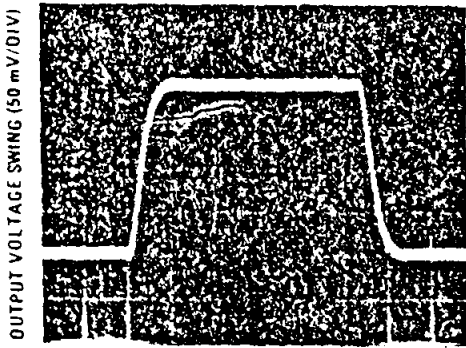

TIME (0.2 $\mu\text{s/DIV}$)

TL147/5647-4

Small Signal Non-Inverting

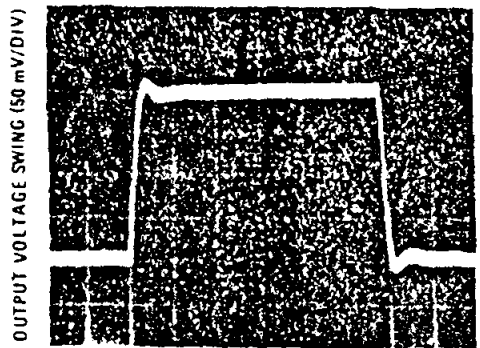

TIME (0.2 $\mu\text{s/DIV}$)

TL147/5647-5

Large Signal Inverting

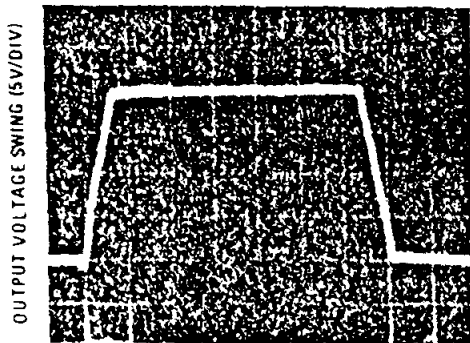

TIME (2 $\mu\text{s/DIV}$)

TL147/5647-6

Large Signal Non-Inverting

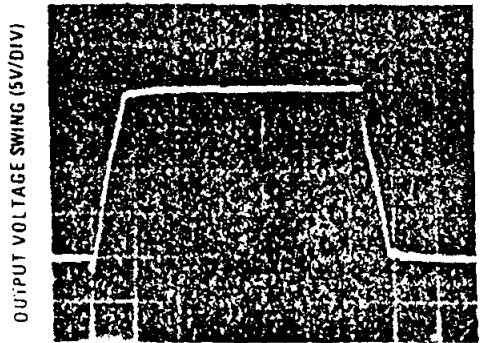

TIME (2 $\mu\text{s/DIV}$)

TL147/5647-7

Current Limit ($R_L = 100\Omega$)

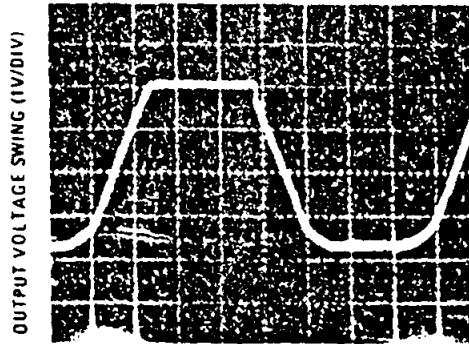

TIME (5 $\mu\text{s/DIV}$)

TL147/5647-8

Application Hints

The LF147 is an op amp with an internally trimmed input offset voltage and JFET input devices (BI-FET II™). These JFETs have large reverse breakdown voltages from gate to source and drain eliminating the need for clamps across the inputs. Therefore, large differential input voltages can easily be accommodated without a large increase in input current. The maximum differential input voltage is independent of the supply voltages. However, neither of the input voltages

should be allowed to exceed the negative supply as this will cause large currents to flow which can result in a destroyed unit.

Exceeding the negative common-mode limit on either input will force the output to a high state, potentially causing a reversal of phase to the output. Exceeding the negative common-mode limit on both inputs will force the amplifier

Application Hints (Continued)

output to a high state. In neither case does a latch occur since raising the input back within the common-mode range again puts the input stage and thus the amplifier in a normal operating mode.

Exceeding the positive common-mode limit on a single input will not change the phase of the output; however, if both inputs exceed the limit, the output of the amplifier will be forced to a high state.

The amplifiers will operate with a common-mode input voltage equal to the positive supply; however, the gain bandwidth and slew rate may be decreased in this condition. When the negative common-mode voltage swings to within 3V of the negative supply, an increase in input offset voltage may occur.

Each amplifier is individually biased by a zener reference which allows normal circuit operation on $\pm 4.5\text{V}$ power supplies. Supply voltages less than these may result in lower gain bandwidth and slew rate.

The LF147 will drive a $2\text{ k}\Omega$ load resistance to $\pm 10\text{V}$ over the full temperature range. If the amplifier is forced to drive heavier load currents, however, an increase in input offset voltage may occur on the negative voltage swing and finally reach an active current limit on both positive and negative swings.

Precautions should be taken to ensure that the power supply for the integrated circuit never becomes reversed in po-

larity or that the unit is not inadvertently installed backwards in a socket as an unlimited current surge through the resulting forward diode within the IC could cause fusing of the internal conductors and result in a destroyed unit.

As with most amplifiers, care should be taken with lead dress, component placement and supply decoupling in order to ensure stability. For example, resistors from the output to an input should be placed with the body close to the input to minimize "pick-up" and maximize the frequency of the feedback pole by minimizing the capacitance from the input to ground.

A feedback pole is created when the feedback around any amplifier is resistive. The parallel resistance and capacitance from the input of the device (usually the inverting input) to AC ground set the frequency of the pole. In many instances the frequency of this pole is much greater than the expected 3 dB frequency of the closed loop gain and consequently there is negligible effect on stability margin. However, if the feedback pole is less than approximately 6 times the expected 3 dB frequency a lead capacitor should be placed from the output to the input of the op amp. The value of the added capacitor should be such that the RC time constant of this capacitor and the resistance it parallels is greater than or equal to the original feedback pole time constant.

Detailed Schematic

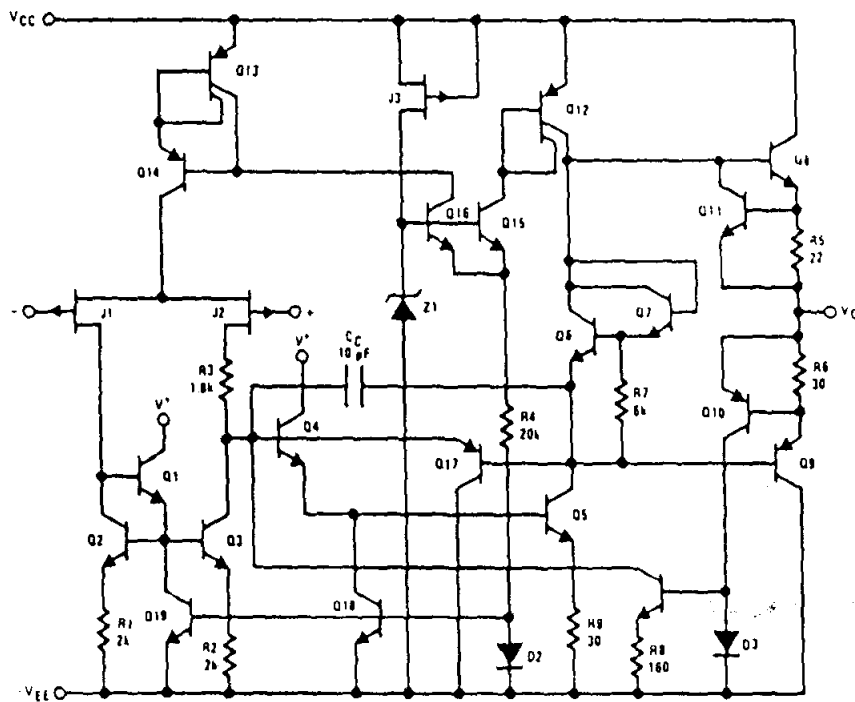

TL/H/5647-9

Typical Applications

Digitally Selectable Precision Attenuator

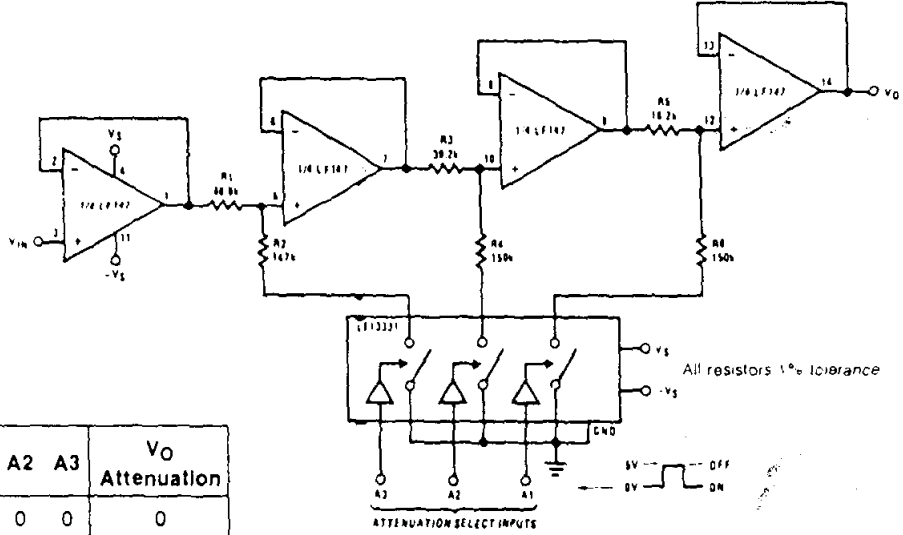

A1	A2	A3	V _O Attenuation
0	0	0	0
0	0	1	-1 dB
0	1	0	-2 dB
0	1	1	-3 dB
1	0	0	-4 dB
1	0	1	-5 dB
1	1	0	-6 dB
1	1	1	-7 dB

ATTENUATION SELECT INPUTS

TL/H/5647-10

- Accuracy of better than 0.4% with standard 1% value resistors
- No offset adjustment necessary
- Expandable to any number of stages
- Very high input impedance

Long Time Integrator with Reset, Hold and Starting Threshold Adjustment

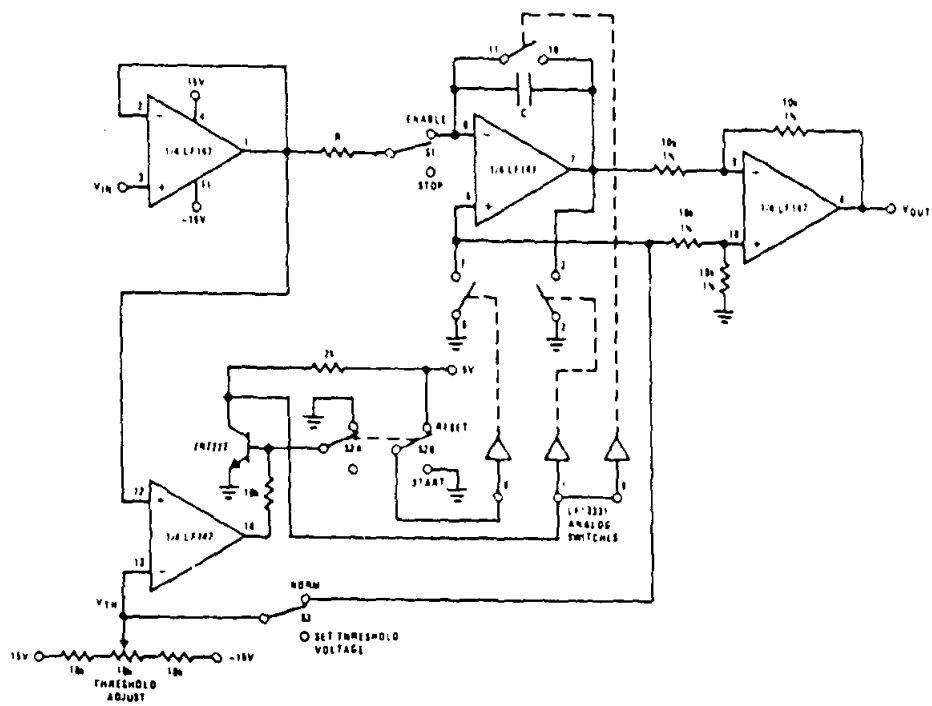

TL/H/5647-11

• V_{OUT} starts from zero and is equal to the integral of the input voltage with respect to the threshold voltage

$$V_{OUT} = \frac{1}{RC} \int_0^t (V_{IN} - V_{TH}) dt$$

- Output starts when V_{IN} > V_{TH}
- Switch S1 permits stopping and holding any output value
- Switch S2 resets system to zero

LF147/LF347

Typical Applications (Continued)

Universal State Variable Filter

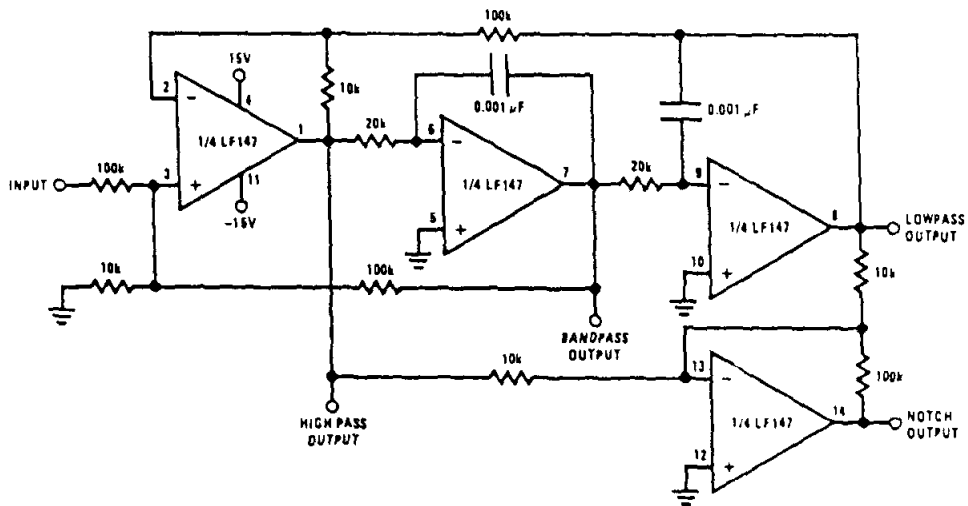

For circuit shown:

$f_0 = 3 \text{ kHz}$, $f_{\text{NOTCH}} = 9.5 \text{ kHz}$

$Q = 3.4$

Passband gain:

Highpass—0.1

Bandpass—1

Lowpass—1

Notch—10

- $f_0 \times Q \leq 200 \text{ kHz}$
- 10V peak sinusoidal output swing without slew limiting to 200 kHz
- See LM148 data sheet for design equations

TL/H/5647-12

BIODATA

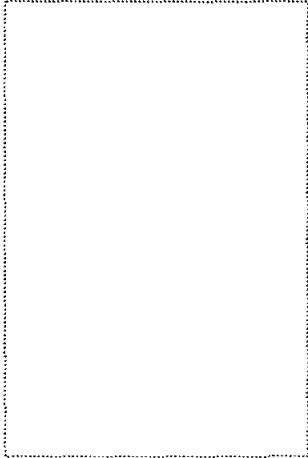

Nama : Yustinus Astanto
NRP : 5103095001
NIRM : 95.7.003.31073.51882
Tempat, Tanggal Lahir : Jember, 3 Januari 1977
Agama : Katolik
Alamat : Jl. Manggar Gg. Mangga
No. 42 / 22 Jember

Riwayat Pendidikan:

- Tahun 1989 Lulus SDK Maria Fatima I Jember.
- Tahun 1992 Lulus SMPK Maria Fatima Jember.
- Tahun 1995 Lulus SMAK Santo Paulus Jember.
- Tahun 2000 Lulus Sarjana Fakultas Teknik Jurusan Teknik Elektro Universitas Katolik Widya Mandala Surabaya.